



# OPERATING INSTRUCTIONS

## SF MODELS



**ARCTIKO**  
Int

<b>INDEX</b> .....	<b>PAGE</b>
<b>Before using the freezer</b> .....	<b>3</b>
<b>Safeguarding the environment</b> .....	<b>3</b>
<b>Precautions and general recommendations</b> .....	<b>3</b>
<b>Operating instructions</b> .....	<b>4</b>
<b>Installing the freezer</b> .....	<b>4</b>
<b>Electrical connection</b> .....	<b>4</b>
<b>Before commissioning</b> .....	<b>5</b>
<b>Start procedure</b> .....	<b>5</b>
<b>Starting up the freezer</b> .....	<b>5</b>
<b>Disconnecting the appliance</b> .....	<b>5</b>
<b>Control panel</b> .....	<b>6</b>
<b>Main functions</b> .....	<b>7</b>
<b>How to lock the keyboard</b> .....	<b>8</b>
<b>Parameters</b> .....	<b>9</b>
<b>Alarms</b> .....	<b>10</b>
<b>Alarm relay management</b> .....	<b>10</b>
<b>Digital input</b> .....	<b>10</b>
<b>Start defrost</b> .....	<b>12</b>
<b>Alarm recovery</b> .....	<b>12</b>
<b>Connections</b> .....	<b>13</b>
<b>Default setting values</b> .....	<b>14</b>
<b>The cooling system</b> .....	<b>15</b>
<b>Service with EP88 for -76°F degree boxes</b> .....	<b>15</b>
<b>Filling procedure</b> .....	<b>15</b>
<b>Relocating or moving the freezer</b> .....	<b>15</b>
<b>Description of changing the lid gasket</b> .....	<b>16</b>
<b>Cleaning and maintenance of the freezer</b> .....	<b>17</b>
<b>Spare parts</b> .....	<b>17</b>
<b>Disposal of the freezer</b> .....	<b>17</b>
<b>Wiring diagram</b> .....	<b>18</b>

## IMPORTANT

### Before using the freezer

For safety reasons, the instructions should be read before the freezer is commissioned. The operating instructions should always be available to the personnel!

Only use the freezer for its specific purpose.

### Safeguarding the environment

1. Packing

The packing material is entirely recyclable and marked with recycling symbol. Please follow the local regulations for scrapping.

2. Appliance.

The freezer is made of recyclable material. Dispose the appliance according to the local environmental regulations.

Make the appliance unusable by cutting off the power supply cord. The appliance must be delivered to an authorised centre for recovery of refrigerant.

### Information

This appliance contains a mixture of different refrigerants. For more information, please refer to the rating plate affixed on the freezer.

### Precautions and general recommendations

**WARNING:** Keep ventilation openings that are placed in the appliance enclosure or in the built-in structure, clear of obstruction.

**WARNING:** Do not use mechanical devices or other means to accelerate the defrosting process, other than those recommended by the manufacturer.

**WARNING:** Do not damage the refrigerant system.

**WARNING:** Do not use electrical appliances inside the freezer storage compartment, unless they are of the type recommended by the manufacturer.

- To prevent children from being trapped, always keep the keys separately and out of reach of children.
- Before servicing or cleaning the appliance, unplug it from the mains or disconnect the electrical power supply.
- The power supply cable may only be replaced by an authorised person.
- Frost formation on the interior wall and upper parts is a natural phenomenon, and therefore the freezer should be defrosted during normal cleaning or maintenance.

### Appliance with flammable refrigerant:

As the appliance contains a mixture of refrigerants, which are flammable, it is essential to ensure that the refrigerant pipes are not damaged.

## Operating Instructions:

### Low Temperature Freezing Box

For safety reasons, these operating instructions should be read before the freezer is commissioned. The operating instructions should always be available to the personnel!

The drawings and symbols in these operating instructions are for safety purposes when commissioning and using the freezer.

Instruct the personnel in the use of the freezer (Can be down to -76°F). There is a risk of frost-bite if the contents or the sides of the inner container are touched!

In the event of breakdown or irregularities contact professional instructors or repair technicians immediately.

### Installing the Freezer

1. Connect the plug from the unit to power. If the electrical connection (the plug) has to be changed, always let an authorised electrician install the freezer (read the operation instructions).
2. The freezer should be located in a dry, cool place without direct sunlight. The freezer gives off a great deal of heat when in operation. If the ambient temperature is too high, there is a risk that the freezer will not operate correctly. It is recommended that the room is ventilated, so that the room temperature does not exceed 77°F at most. Class N.
3. Place the freezer on a solid and flat substrate. This will eliminate any vibration and irritating noise. The freezer should be placed with at least 4 in. free to the sides, at least 6 in. free at the back, and at least 40 in. free to the ceiling.

### Electrical connection:

Trouble-free operation, this unit must be properly grounded before it is used. Failure to ground the equipment may cause personal injury or damage to the equipment. Always conform to the National Electrical Code and local codes. Do not connect the unit to overloaded power lines.

Data regarding voltage and absorbed power / current are given on the rating plate placed on the rear side of the freezer.

SF150/400: 120V / 60Hz / 5,0 Amp.

SF500: 120V / 60Hz / 6,3 Amp.

Electrical connection must be made in accordance with the local regulations.

Use of extension cord is not allowed.

For installation see wiring diagram.

## **Warning:**

### **Regulations require that this appliance must be earthed**

The manufacturer declines all liability for injury to persons or animals and for damage to property resulting from failure to observe the above procedures and reminders.

If the socket and plug are not of the same type, please have the plug or socket replaced by a qualified electrician.

Do under no circumstances use extension leads or adaptors.

1. The freezer should be connected by an authorised electrician or by the company, which sold the freezer! Incorrect installation may damage the freezer.
2. Place the freezer on a flat floor, which can take the weight of the freezer.
3. The electrical installation should be earthed.
4. Do not use extension cables, but connect the freezer directly to a fixed installation.
5. The freezer should be placed in a dry location, and should not be subjected to water on the cabinet. If water gets into the electrical parts it may cause short-circuiting.
6. In the event of functional or electrical irregularities, please contact an authorised servicing engineer.

### **Before commissioning**

Clean the freezer both inside and out using a damp, wrung out cloth. Dry with a dry cloth.

The smell from the plastic parts in the freezer will disappear once the freezer has been cooled down.

### **Start procedure**

Put the plug in the socket.

The thermostat/thermometer will start to flash. The thermostat was pre-set by the producer. The freezer should run for at least 6 hours before the thermostat is changed. (Stabilisation of the cooling system).

The alarm function will not start before the temperature has reached temperature St1 = set point for the first time.

### **Starting up the freezer**

Start the freezer. Set the thermostat at the temperature required. It will now take about 4-5 hours before the set temperature is reached. The freezer should be cooled down without anything in it.

### **Disconnecting the appliance**

Electrical disconnecting must be possible either by unplugging the appliance or by means of a double pole switch located up-line from the socket.

## CONTROL PANEL (Dixell XR30CX Controller)



Figure 1

**SET:** To display target set point; in programming mode it selects a parameter or confirm an operation.

**(DEF):**  To start a manual defrost

**(UP):**  To see the max. stored temperature; in programming mode it browses the parameter codes or increases the displayed value.

**(DOWN):**  To see the min stored temperature; in programming mode it browses the parameter codes or decreases the displayed value.

 To switch the instrument off, if onF = OFF.

 **NOT USED**

### KEY COMBINATIONS:







 +  To lock & unlock the keyboard.

**SET** +  To enter in programming mode.



**SET** +  To return to the room temperature display.

### USE OF LEDS



Each LED function is described in the following table

LED	MODE	FUNCTION
	ON	Compressor enabled
	Flashing	Anti-short cycle delay enabled
	ON	Defrost enabled
	ON	An alarm is occurring
	ON	Continuous cycle is running
	ON	Energy saving enabled
°C/°F	ON	Measurement unit
°C/°F	Flashing	Programming phase

### HOW TO SEE THE MIN TEMPERATURE

1. Press and release the  key.
2. The “Lo” message will be displayed followed by the minimum temperature recorded.
3. By pressing the  key again or by waiting 5s the normal display will be restored.

### HOW TO SEE THE MAX TEMPERATURE

1. Press and release the  key.
2. The “Hi” message will be displayed followed by the maximum temperature recorded.
3. By pressing the  key again or by waiting 5s the normal display will be restored.

## HOW TO RESET THE MAX AND MIN TEMPERATURE RECORDED

1. Hold press the SET key for more than 3s, while the max. or min temperature is displayed. (rSt message will be displayed)
2. To confirm the operation the “rSt” message starts blinking and the normal temperature will be displayed.

## MAIN FUNCTIONS

### HOW TO SEE THE SETPOINT



1. Push and immediately release the **SET** key: the display will show the Set point value;
2. Push and immediately release the **SET** key or wait for 5 seconds to display the probe value again.

### HOW TO CHANGE THE SETPOINT

1. Push the SET key for more than 2 seconds to change the Set point value;
2. The value of the set point will be displayed and the “°C” or “°F” LED starts blinking;
3. To change the Set value push the ▲ or ▼ arrows within 10s.
4. To memorise the new set point value push the SET key again or wait 10s.

### HOW TO START A MANUAL DEFROST



Push the **DEF** key for more than 2 seconds and a manual defrost will start.

### HOW TO CHANGE A PARAMETER VALUE

To change the parameter’s value operate as follows:



1. Enter the Programming mode by pressing the **Set and DOWN** key for 3s (the “°C” or “°F” LED starts blinking).
2. Select the required parameter.
3. Press the “**SET**” key to display its value.
4. Use “**UP**” or “**DOWN**” to change its value.
5. Press “**SET**” to store the new value and move to the following parameter. **To exit:** Press **SET + UP** or wait 15s without pressing a key.

**NOTE:** the set value is stored even when the procedure is exited by waiting the time-out to expire.

## THE HIDDEN MENU

The hidden menu Includes all the parameters of the instrument.

### 6.6.1 HOW TO ENTER THE HIDDEN MENU



1. Enter the Programming mode by pressing the Set+ ▼ key for 3s (the “°C” or “°F” LED starts blinking).
2. Released the keys, then push again the Set+ ▼ keys for more than 7s. The Pr2 label will be displayed immediately followed from the HY parameter.

**NOW YOU ARE IN THE HIDDEN MENU.**

3. Select the required parameter.
4. Press the “**SET**” key to display its value.
5. Use ▲ or ▼ to change its value.
6. Press “**SET**” to store the new value and move to the following parameter. **To exit:** Press **SET + ▲** or wait 15s without pressing a key.

**NOTE1:** if none parameter is present in Pr1, after 3s the “noP” message is displayed. Keep the keys pushed till the Pr2 message is displayed.

**NOTE2:** the set value is stored even when the procedure is exited by waiting the time-out to expire.

### 6.6.2 HOW TO MOVE A PARAMETER FROM THE HIDDEN MENU TO THE FIRST LEVEL AND VICEVERSA.

Each parameter present in the HIDDEN MENU can be removed or put into “THE FIRST LEVEL” (user level) by pressing “**SET**” + ▼

In HIDDEN MENU when a parameter is present in First Level the decimal point is on.

#### HOW TO LOCK THE KEYBOARD



1. Keep pressed for more than 3 s the ▲ and ▼ keys.
2. The “**POF**” message will be displayed and the keyboard will be locked. At this point it will be possible only to see the set point or the MAX o Min temperature stored
3. If a key is pressed more than 3s the “**POF**” message will be displayed.

#### TO UNLOCK THE KEYBOARD

Keep pressed together for more than 3s the ▲ and ▼ keys, till the “**Pon**” message will be displayed.

#### THE CONTINUOUS CYCLE



When defrost is not in progress, it can be activated by holding the ▲ key pressed for about 3 seconds.

The compressor operates to maintain the “**ccS**” set point for the time set through the “**Cct**” parameter. The cycle can be terminated before the end of the set time using the same activation key “ ▲ ” for 3 seconds.

#### THE ON/OFF FUNCTION

With “**onF = oFF**”, pushing the **ON/OFF** key, the instrument is switched off. The “**OFF**” message is displayed. In this configuration, the regulation is disabled. To switch the instrument on, push again the **ON/OFF** key.

**WARNING:** Loads connected to the normally closed contacts of the relays are always supplied and under voltage, even if the instrument is in stand by mode.



## PARAMETERS

### REGULATION

- Hy Differential:** (0,1 ÷ 25,5°C / 1÷255 °F) Intervention differential for set point. Compressor Cut IN is Set Point + differential (Hy). Compressor Cut OUT is when the temperature reaches the set point.
- LS Minimum set point:** (-100°C ÷ SET; [-148F ÷ SET]): Sets the minimum value for the set point.
- US Maximum set point:** (SET÷150°C/ SET÷302°F). Set the maximum value for set point.
- Ot Thermostat probe calibration:** (-12.0÷12.0°C; -120÷120°F) allows to adjust possible offset of the thermostat probe.
- Ods Outputs activation delay at start up:** (0÷255min) This function is enabled at the initial start up of the instrument and inhibits any output activation for the period of time set in the parameter.
- AC Anti-short cycle delay:** (0÷50 min) minimum interval between the compressor stop and the following restart.
- CCt Compressor ON time during continuous cycle:** (0.0÷24.0h; res. 10min) Allows to set the length of the continuous cycle: compressor stays on without interruption for the Cct time. Can be used, for instance, when the room is filled with new products.
- CCS Set point for continuous cycle:** (-100÷150°C; -148°F ÷ 302°F) it sets the set point used during the continuous cycle.
- Con Compressor ON time with faulty probe:** (0÷255 min) time during which the compressor is active in case of faulty thermostat probe. With Con=0 compressor is always OFF.
- COF Compressor OFF time with faulty probe:** (0÷255 min) time during which the compressor is OFF in case of faulty thermostat probe. With COF=0 compressor is always active.
- CH Type of action:** CL = cooling; Ht = heating.

### DISPLAY

- CF Temperature measurement unit:** °C=Celsius; °F=Fahrenheit. WARNING: When the measurement unit is changed the SET point and the values of the parameters Hy, LS, US, Ot, ALU and ALL have to be checked and modified if necessary).
- rES Resolution (for °C):** (in = 1°C; dE = 0.1 °C) allows decimal point display.
- dLy Display delay:** (0 ÷20.0m; risul. 10s) when the temperature increases, the display is updated of 1 °C/1°F after this time.

### DEFROST

- IdF Interval between defrost cycles:** (0÷120h) Determines the time interval between the beginning of two defrost cycles.
- MdF (Maximum) length for defrost:** (0÷255min) When **P2P = n**, (not evaporator probe: timed defrost) it sets the defrost duration, when **P2P = y** (defrost end based on temperature) it sets the maximum length for defrost.
- dFd Temperature displayed during defrost:** (rt = real temperature; it = temperature at defrost start; SET = set point; dEF = “dEF” label)
- dAd MAX display delay after defrost:** (0÷255min). Sets the maximum time between the end of defrost and the restarting of the real room temperature display.

## ALARMS

### ALC Temperature alarms configuration: (Ab; rE)

Ab= absolute temperature: alarm temperature is given by the ALL or ALU values. rE = temperature alarms are referred to the set point. Temperature alarm is enabled when the temperature exceeds the "SET+ALU" or "SET-ALL" values.

**ALU MAXIMUM temperature alarm:** (SET+150°C; SET+302°F) when this temperature is reached the alarm is enabled, after the "ALd" delay time.

**ALL Minimum temperature alarm:** (-100.0 ÷ SET°C; -148÷302°F) when this temperature is reached the alarm is enabled, after the "ALd" delay time.

**AFH Differential for temperature alarm recovery:** (0,1÷25,5°C; 1÷45°F) Intervention differential for recovery of temperature alarm.

**Ald Temperature alarm delay:** (0÷255 min) time interval between the detection of an alarm condition and alarm signalling.

**dAo Exclusion of temperature alarm at startup:** (from 0.0 min to 23.5h) time interval between the detection of the temperature alarm condition after instrument power on and alarm signalling.

## ALARM RELAY MANAGEMENT

**tbA Alarm relay silencing (with oA1=ALr):** (n= silencing disabled: alarm relay stays on till alarm condition lasts, y =silencing enabled: alarm relay is switched OFF by pressing a key during an alarm).

### Aro Alarm relay activation with power failure:

y = the alarm relay is activated if a temperature alarm happens during a power failure

n = the alarm relay is never activated during a power failure

### ALF Alarm relay activation for all the alarms:

y = the alarm relay is activated for all the alarms

n = the alarm relay is activated only in case temperature alarms and regulation probe failure.

**bon Time of buzzer restart after muting, in case of alarm duration:** (0÷30min; with 0 the buzzer is always off after muting)

**AoP Alarm relay polarity:** it set if the alarm relay is open or closed when an alarm happens.

CL= terminals 1-2 closed during an alarm; oP = terminals 1-2 open during an alarm

## DIGITAL INPUT

**i1P Digital input polarity:** oP: the digital input is activated by opening the contact; CL: the digital input is activated by closing the contact.

**i1F Digital input configuration:** EAL = external alarm: "EA" message is displayed; bAL = serious alarm "CA" message is displayed. PAL = pressure switch alarm, "CA" message is displayed; dor = door switch function; dEF = activation of a defrost cycle; AUS =to switch on the second relay if oA1 = AUS; Htr = kind of action inversion (cooling – heating); FAn = not set it; ES = Energy saving.

**did: (0÷255 min) with i1F= EAL or i1F = bAL digital input alarm delay:** delay between the detection of the external alarm condition and its signalling.

**with i1F= dor: door open signalling delay**

**with i1F = PAL: time for pressure switch function:** time interval to calculate the number of the pressure switch activation.

- nPS Pressure switch number:** (0 ÷15) Number of activation of the pressure switch, during the “did” interval, before signalling the alarm event (I2F= PAL). If the nPS activation in the did time is reached, switch off and on the instrument to restart normal regulation.
- odc Compressor status with door open:** no, Fan = normal; CPr; F\_C = Compressor OFF.
- rd Outputs restart after doA alarm:** no = outputs not affected by the doA alarm; yES = outputs restart with the doA alarm;
- HES Temperature increase during the Energy Saving cycle:** (-30,0°C÷30,0°C/-22÷86°F) it sets the increasing value of the set point during the Energy Saving cycle.

## OTHER

- Adr Serial address** (1÷244): Identifies the instrument address when connected to a ModBUS compatible monitoring system.
- PbC Type of probe:** it allows to set the kind of probe used by the instrument: PTC = PTC probe, Pt1 = Pt1000 probe.
- onF on/off key enabling:** nu = disabled; oFF = enabled; ES = not set it.
- rSE Real set point:** (readable only), it shows the set point used during the energy saving cycle or during the continuous cycle.
- rEL Software release** for internal use.
- Ptb Parameter table code:** readable only.

## DIGITAL INPUT

The free voltage digital input is programmable in different configurations by the “i1F” parameter.

### DOOR SWITCH INPUT (i1F = dor)

It signals the door status and the corresponding relay output status through the “odc” parameter: **no, Fan** = normal (any change); **CPr, F\_C** = Compressor OFF.

Since the door is opened, after the delay time set through parameter “did”, the door alarm is enabled, the display shows the message “**da**” and the regulation restarts is **rtr = yES**. The alarm stops as soon as the external digital input is disabled again. With the door open, the high and low temperature alarms are disabled.

### GENERIC ALARM (i1F = EAL)

As soon as the digital input is activated the unit will wait for “**did**” time delay before signalling the “**EAL**” alarm message. The outputs status don’t change. The alarm stops just after the digital input is de-activated.

### SERIOUS ALARM MODE (i1F = bAL)

When the digital input is activated, the unit will wait for “**did**” delay before signalling the “**CA**” alarm message. The relay outputs are switched OFF. The alarm will stop as soon as the digital input is de-activated.

### PRESSURE SWITCH (i1F = PAL)

If during the interval time set by “**did**” parameter, the pressure switch has reached the number of activation of the “**nPS**” parameter, the “**CA**” pressure alarm message will be displayed. The compressor and the regulation are stopped. When the digital input is ON the compressor is always OFF.

**If the nPS activation in the did time is reached, switch off and on the instrument to restart normal regulation.**

### START DEFROST (i1F = dFr)

It starts a defrost if there are the right conditions. After the defrost is finished, the normal regulation will restart only if the digital input is disabled otherwise the instrument will wait until the “MdF” safety time is expired.

### INVERSION OF THE KIND OF ACTION: HEATINGCOOLING (i1F = Htr)

This function allows to invert the regulation of the controller: from cooling to heating and viceversa.

### ENERGY SAVING (i1F = ES)

The Energy Saving function allows to change the set point value as the result of the SET+ HES (parameter) sum. This function is enabled until the digital input is activated.

### DIGITAL INPUTS POLARITY

The digital input polarity depends on the “i1P” parameter.

**i1P=CL:** the input is activated by closing the contact.

**i1P=OP:** the input is activated by opening the contact

### ALARM SIGNALS

Message	Cause	Outputs
“P1”	Room probe failure	Compressor output acc. to par. “Con” and “COF”
“HA”	Maximum temperature alarm	Outputs unchanged.
“LA”	Minimum temperature alarm	Outputs unchanged.
“dA”	Door open	Compressor according to rrd
“EA”	External alarm	Output unchanged.
“CA”	Serious external alarm (i1F=bAL)	All outputs OFF.
“CA”	Pressure switch alarm (i1F=PAL)	All outputs OFF

### ALARM RECOVERY

Probe alarm “P1” starts some seconds after the fault in the related probe; it automatically stops some seconds after the probe restarts normal operation. Check connections before replacing the probe. Temperature alarms “HA” and “LA” automatically stop as soon as the thermostat temperature returns to normal values.

Alarms “EA” and “CA” (with i1F=bAL) recover as soon as the digital input is disabled.

Alarm “CA” (with i1F=PAL) recovers only by **switching off and on** the instrument.

### OTHER MESSAGES

Pon	Keyboard unlocked.
PoF	Keyboard locked
noP	<b>In programming mode:</b> none parameter is present in Pr1 <b>On the display</b> or in dP2, dP3, dP4: the selected probe is nor enabled
noA	<b>None alarm is recorded.</b>

## CONNECTIONS

### XR30CX: 20A COMPRESSOR

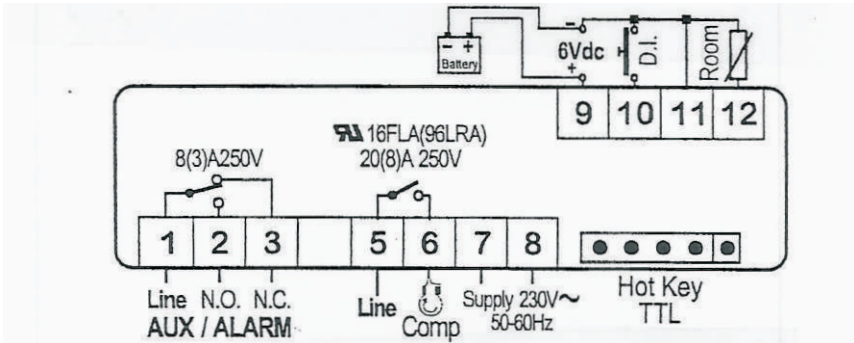

12Vac/dc supply: connect to the terminals 7 and 8.

24Vac/dc supply: connect to the terminals 7 and 8.

120Vac supply: connect to the terminals 7 and 8.

## DEFAULT SETTING VALUES

Label	Name	Range	Set point	Pr 1/2
<b>Set</b>	Set point	LS÷US	-62	---
<b>Hy</b>	Differential	0,1÷25,5°C/1÷255°F	1	Pr1
<b>LS</b>	Minimum set point	-50°C÷SET/-58°F÷SET	-63	Pr2
<b>US</b>	Maximum set point	SET÷110°C/SET÷230°F	-30	Pr2
<b>Ot</b>	Thermostat probe calibration	-12÷12°C/-120÷120°F	0	Pr1
<b>OdS</b>	Outputs delay at start up	0÷255min	0	Pr2
<b>AC</b>	Anti-short cycle delay	0÷50min	5	Pr1
<b>CCt</b>	Continuous cycle duration	0,0÷24.0h	0,0	Pr2
<b>CCS</b>	Set point for continuous cycle	(-55,0÷150,0°C)(-67÷302°F)	-62	Pr2
<b>COn</b>	Compressor ON time with faulty probe	0÷255min	60	Pr2
<b>COF</b>	Compressor OFF time with faulty probe	÷255min	5	Pr2
<b>CH</b>	Kind of action	CL=cooling; Ht=heating	CL	Pr2
<b>CF</b>	Temperature measurement unit	°C÷°F	°C	Pr2
<b>rES</b>	Resolution	In=integer; dE=dec.point	in	Pr2
<b>dLy</b>	Display temperature delay	0÷20,0min (10sec.)	0	Pr2
<b>IdF</b>	Interval between defrost cycles	1÷120ore	0	Pr1
<b>MdF</b>	(Maximum) length for defrost	0÷255min	0	Pr1
<b>dFd</b>	Displaying during defrost	rt, it, Set, DEF	rt	Pr2
<b>dAd</b>	MAX display delay after defrost	0÷255min	0	Pr2
<b>ALc</b>	Temperature alarms configuration	rE=related to set; Ab=absolute	rE	Pr2
<b>ALU</b>	Maximum temperature alarm	Set÷110,0°C; Set÷230°F	15	Pr1
<b>ALL</b>	Minimum temperature alarm	-50,0°C÷Set/ -58°F ÷Set	-50,0	Pr1
<b>AFH</b>	Differential for temperature alarm recovery	(0,1°C÷25,5°C)(1°F÷45°F)	1	Pr2
<b>ALd</b>	Temperature alarm delay	0÷255min	0	Pr2
<b>dAo</b>	Delay of temperature alarm at start up	0÷23h e 50'	1.3	Pr2
<b>tbA</b>	Alarm relay disabling	n=no; y=yes	y	Pr2
<b>Aro</b>	Alarm relay activation with power failure	n(0) – y(1)	y	Pr2
<b>ALF</b>	Alarm relay activation for all the alarms	n(0) – y(1)	y	Pr2
<b>bon</b>	Time of buzzer restart after muting, in case of alarm duration	0 ÷ 30 (min)	30	Pr2
<b>AoP</b>	Alarm relay polarity (0A1=ALr)	oP; cL	cL	Pr2
<b>i1P</b>	Digital input polarity	oP=opening; cL=closing	cL	Pr1
<b>i1F</b>	Digital input configuration	EAL, bAL,PAL, dor; dEF; Htr, AUS	AUS	Pr1
<b>did</b>	Digital input alarm delay	0÷255min	15	Pr1
<b>nPS</b>	Number of activation of pressure switch	0÷15	15	Pr2
<b>odc</b>	Compress status when open door	No; Fan;CPr;F_C	no	Pr2
<b>rrd</b>	Regulation restart with door open alarm	n - y	y	Pr2
<b>HES</b>	Differential for Energy Saving	(-30°C÷30°C)(-54°F÷54°F)	1	Pr2
<b>Adr</b>	Serial address	0÷247	1	Pr2
<b>PbC</b>	Kind of probe	Ptc; ntc	Pt1	Pr2
<b>onF</b>	On/off key enabling	Nu, oFF; ES	OFF	Pr2
<b>rSE</b>	Real set point value	Actual set	---	Pr2
<b>rEL</b>	Software release	---	---	Pr2

## **The cooling system:**

The vaporiser is built into the wall of the inner container. This will be -76°F, so there is a risk of frostbite if it is touched. Always use thermal gloves when touching the contents of the freezer.

The evaporator is placed on the inside of the cabinet. This means that the outside of the cabinet gets hot when in operation. The advantage of a hot cabinet is that it will always be dry.

The advantage of freezing boxes is that only a minimum amount of heat gets in when they are opened and closed.

Thermostat with digital display. Once the freezer is cooled down, the set temperature and the temperature shown will be the same.

## **Service with EP88 for - 76°F degree boxes:**

Note that the EP-88 gas can only be filled from a bottle containing a measured amount. Normal procedures used in conjunction with other refrigerants cannot be used.

Furthermore note that the freezing capability is very dependent upon filling the entire contents of the bottle into the system. Freezing capability is also very dependent upon the temperature of the EP88 and whether it has been still for a long period of time. The temperature of the service bottle must be between 47 and 57°F degrees, and the contents must be mixed by shaking the bottle 10-15 times.

In order to carry out the service procedure correctly, it is necessary to use a capillary pipe with mounting screws between the bottle and the filling station instead of a normal filling hose. The service technician may do this by using the mounting screws of a normal filling hose onto a capillary pipe.

## **Filling procedure:**

- Empty the system and evacuate to 02 mbar. Evacuation must be performed at two places in the system; both from the filling pipe and from the pipe mounted on the pressure side of the compressor.
- Mount the capillary pipe with mounting screws between the filling station and the service bottle.
- Unlike with other refrigerants, the service bottle must be turned tap-down.
- Commence filling.
- The compressor will start after approx. 10-15 seconds of filling.
- The bottle is empty when the pressure falls to 1bar and must be shut immediately. Immediate shutting of the bottle is very important to prevent the fluid being pushed back into the bottle.
- Close the system.

## **Relocating or moving the freezer:**

Never leave the freezer to others without instructing these people in its use and the safety regulations described in the operating instructions. Always let an authorised electrician install the freezer. (Remember to wait for one hour before restarting it).

If the freezer and its electrical parts are reconstructed, the guarantee and safety regulations shall cease to apply.

If the freezer does not work: call an authorised servicing engineer!

Contact the distributor or an authorised service repair shop!

## Description of changing the lid gasket

### Tools and materials needed for the change

Screwdriver (if possible electric), knife (keen), screws with flat head and a new gasket.

**1.**

The old gasket is cut off as close to the lid as possible.



**2.**

The new gasket is placed on the table with the underneath of the gasket up.

The loose fold which is up is cut off. Beware not to damage the rest of the gasket.

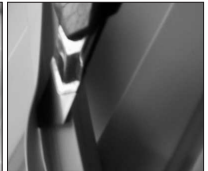
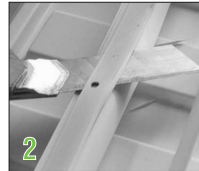

**3.**

The new gasket with the removed fold is placed on the lid.



**4.**

The upper part of the gasket is twisted outwards, and the screws are mounted with approx. 10cm (4 inches) distance. Always begin the mounting from one corner and out (both directions) and from all four corners. Be aware not to stretch the gasket during mounting this will result in incorrect mounting.



**5.**

After mounting the new gasket the lid will look just like before.





## **Cleaning and maintenance of the freezer**

1. Ice will form on the sub lids in the freezer. This ice should be removed with a scraper at regular intervals. (Remember safety gloves).
2. Ice on the inside of the box should be removed as required, as it reduces the cooling capacity! Take the contents out of the freezer. Pull out the plug and leave the lid open until the ice can be removed. (Remember safety gloves).
3. Dry the inner container with a cloth until it is not damp any longer!
4. Clean the outside of the freezer with a damp cloth. Be careful not to get damp (water) on the electrical parts or water into the vent holes, as water and damp may damage the electrical parts and cause the freezer to short-circuit!
5. The ice formed on the inside of the lid should be removed with a wooden/plastic scraper. This ice will build up because of the low temperatures inside the box, and if it is not removed it will cause the lid to open.
6. Use authorised cleaning products. The use of alcohol, dissolvents and alkaline cleaning agents is prohibited.
7. Clean the vent holes on the rear condenser with a vacuum cleaner at least once a year (see the sketches).

Do not put bottles containing carbonic acid or inflammable products in the freezer.

## **WARNING**

Before carrying out maintenance, unplug the appliance.

Do not use abrasive products; stain removers (e.g. acetone, trichloroethylene) to clean the appliance.

## **Spare parts**

When ordering spare parts that you can easily fit yourself, please give unit type number and the function of the part(s) concerned.

## **Disposal of the freezer**

To prevent harmful environmental effects, contact the distributor and ask where the freezer should be delivered.

Remove the locking function so that children cannot be locked in the freezer whilst playing.

You can obtain information on the disposal of refrigeration appliances from:

- Your supplier
- Authorities (The Local council, Ministry of the Environment, etc.)

# Wire-diagram

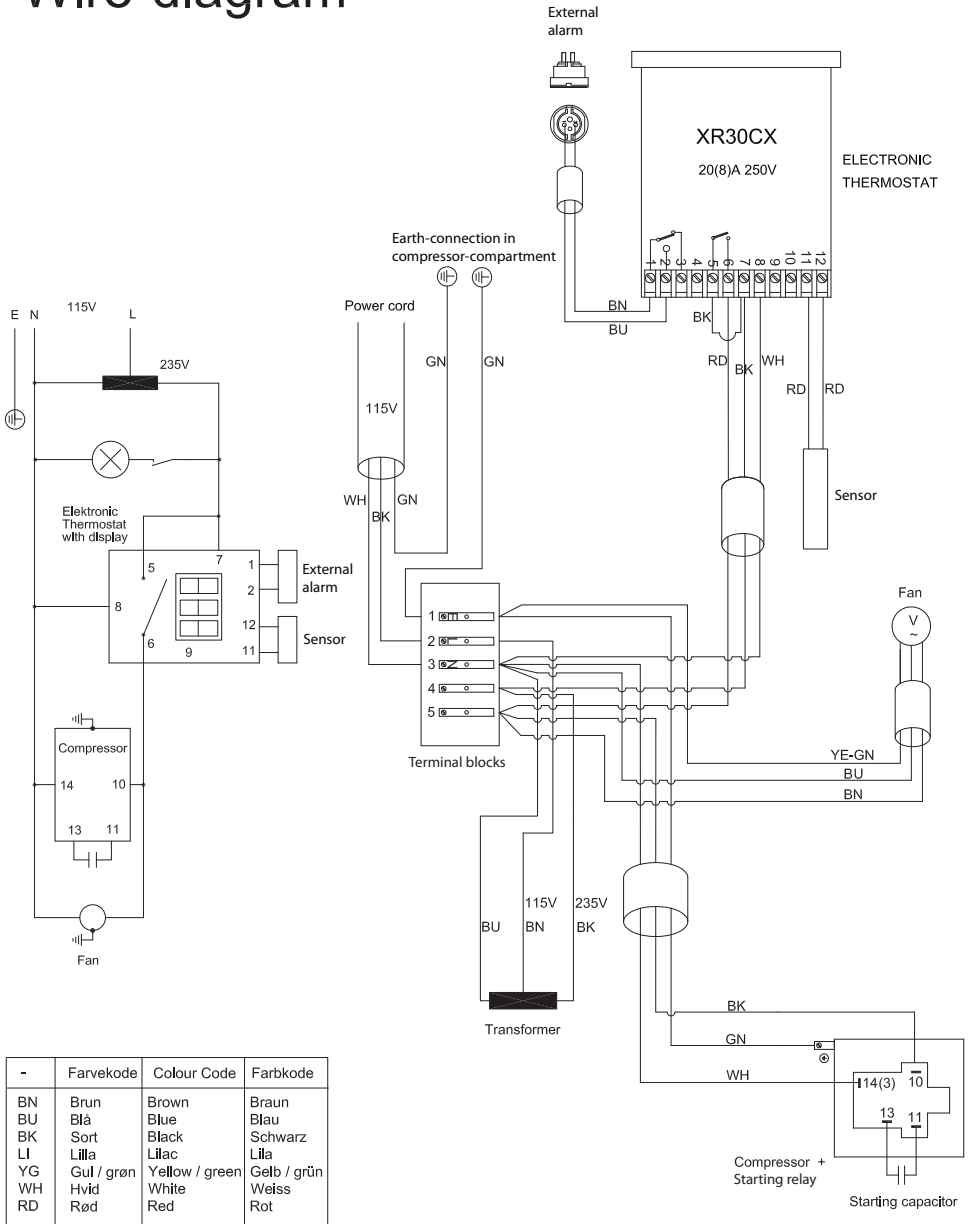





**WWW.ARCTIKO-INT.COM**

ODDESUNDVEJ 39  
DK-6715 ESBJERG N  
DENMARK

TEL. +45 70 20 03 28

FAX. +45 70 20 03 29

WWW.ARCTIKO.COM